

Olympia

1375.60LE/OiE

DESIGN

Rotisol's traditional rustic-style rotisserie, the Olympia, is an attractive show-piece for any restaurant or kitchen and is used by chefs in Michelin's star restaurants around the world.

The visible flames from Rotisol's patented burners spread up the porcelain wicks creating a spectacular visual that can be seen through the front and side glass doors.

Spits are driven by an elegant system of chains and pulleys, rotating at 2 ½ times per minute, ensuring perfectly cooked, self-basting poultry, meat, vegetables and fish.

The optional Vertical Spit System with its choice of eight hanging accessories expands the menu possibilities even more and adds additional visual appeal.

FEATURES

- Reinforced and anti warping heating element
- Tempered K-glass front and side doors
- Decorative roof included
- Pre-installed vertical spit system
- Independent motor for each spit
- Equipped with bottom drip tray with built-in drainage
- Powerful halogen lamps
- Delivered with 6 prongless spits (CUI13)
- Base on casters with brakes

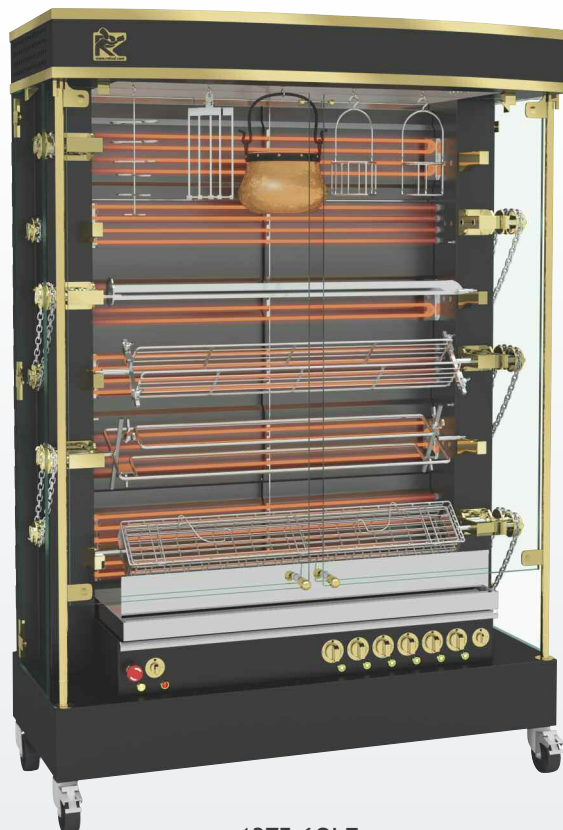





1375.60LE
Black enamel and brass



TECHNICAL DETAILS

Overview of some of the standard features.

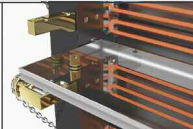
	Emergency stop button type «punch» easily accessible.		Visible rustic pulleys and drive chains for added front-of-house appeal		Pre-installed vertical spit system allows for vertical cooking
	Reinforced heating elements with stainless steel holders to keep them in place and removable stainless steel panels for easy cleaning.		Knobs in brass or chrome finish.		Middle drip pan allows separation of products to prevent cross-contamination

ACCESSORIES

A wide variety of accessories are available. Please consult us. See video of available [accessories](#) and of [vertical spit system](#) online.

CUI13 Anti-cutting prongless V-spit.		BP13 Chicken spit.		BRC13 Rectangular basket spit.	
BS13 Spit for ham / turkey.		BRRO13 Roast-clamp spit.		BA13 Lamb/suckling-pig spit.	
BCR13 Spatchcock chicken basket.		DEC Spit mover.		PID13 Tray for unspitting.	

Front view

Rotisserie with roof
and base on casters (optional)

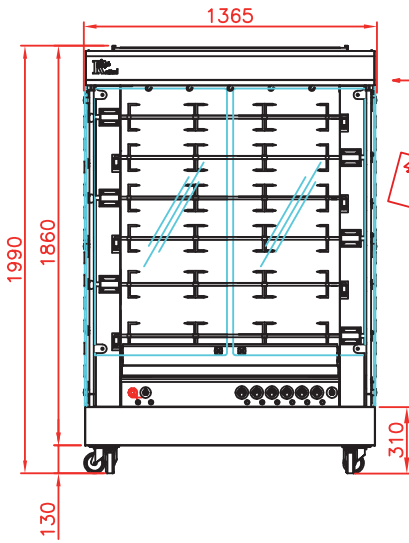

GRANDES FLAMMES
OLYMPIA

4 securit glass doors
"K" system

Electrical
Connection, in rear

Side view

Rotisserie with roof
and base on casters (optional)

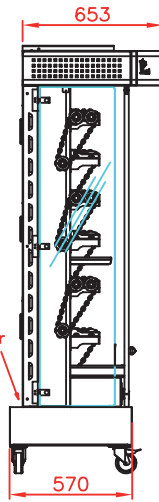

Top view

Rotisserie with roof
and base on casters (optional)

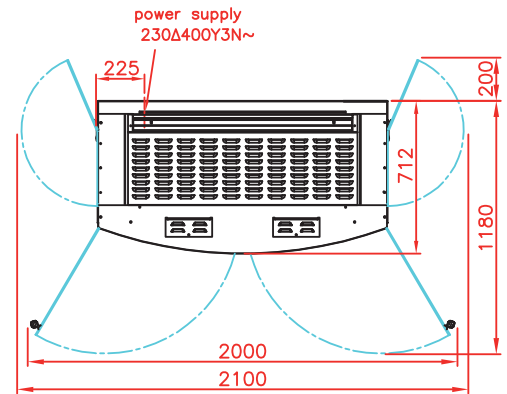

1375.60iE
Stainless steel



Revised :
July 2019

SPECIFICATIONS

Capacity	30/36 poulties
Power supply	400 Volts 3 phases+neutral+earth
Electrical power	37 kW
Weight and size (HxDxW)	415 kg ; 1990 x 712 x 1365 mm
Shipping weight and size	466 kg ; 2120 x 760 x 1500 mm
Guarantee	1 year parts



DISTRIBUTOR / AGENT

Rotisol S.A.S.

Zone industrielle La Trentaine, Avenue Gustave Eiffel

77507 Chelles cedex - FRANCE

s.bennell@rotisol.com - Tel : +33 1 64 21 80 00

www.rotisol.com