

# Millenium

## 975.2MLG/MSG + i

### DESIGN

Rotisol's most popular line, the Millenium combines the drama of visible flames and the beauty of elegant finishes with the highest degree of functionality.

A wide array of spits allow the chef to cook anything that can be roasted: whole or split chickens, lamb, beef roasts and steaks, cuts of pork, fish, vegetables, even fruit.

The optional Vertical Spit System with its choice of eight hanging accessories expands the menu possibilities even more and adds additional visual appeal.

### FEATURES

- Energy efficient
- Tempered K-glass doors
- Independent motor for each spit
- Equipped with bottom drip tray with built-in drainage
- Rotisol patented burners
- Powerful halogen lamps
- Delivered with 3 prongless spits (CUI975)
- Illuminated sign «Rôtisserie» for enamel model only
- Base on casters with brakes

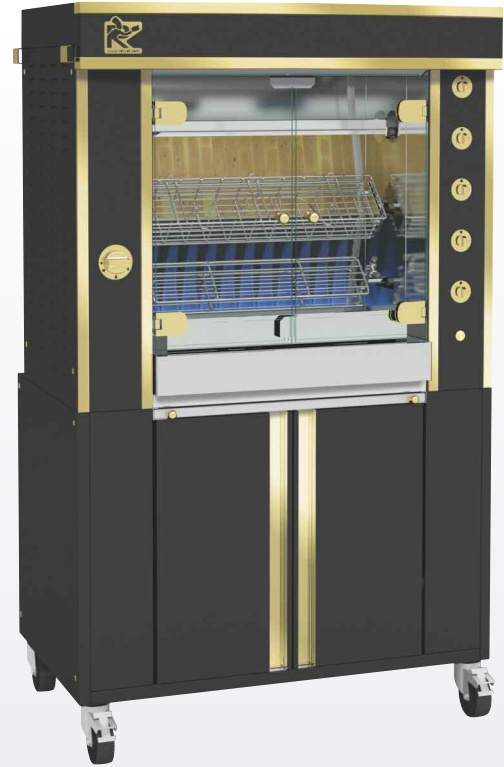

975.2MLG  
Black enamel and brass



### TECHNICAL DETAILS

Overview of some of the standard features.



Stainless steel burner with removable air filter (Rotisol patent).

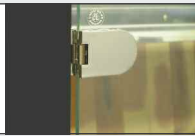

Robust hinges designed for heavy use, with integrated locking in open and closed positions.

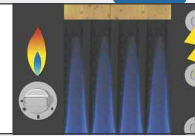

Gas safety ! separation of the gas and electric chambers avoids any risks of explosion.

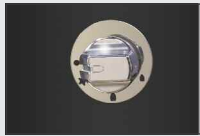

Gas and electric switches, in chromed or brass-colored metal.

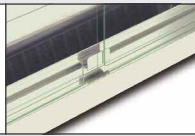

Anti-scald K-glass reduces external thermal radiation (energy saving). Glass overlaps drip pan to keep splatters inside (anti-slip protection).



Removable inside side-panels doubles protection from grease seeping into motors and other sensitive parts.

### ACCESSORIES

A variety of accessories are available. See video of available [accessories](#) and of [vertical spit system](#) online.

<b>CUI975</b> Anti-cutting prongless V-spit.		<b>BP975</b> Chicken spit.		<b>BRC975</b> Rectangular basket spit.	
<b>BS975</b> Spit for ham / turkey.		<b>BRRO975</b> Roast-clamp spit.		<b>BA975</b> Lamb/suckling-pig spit.	
<b>BCR975</b> Spatchcock chicken basket.		<b>DEC</b> Spit mover.		<b>PID975</b> Tray for unspitting.	

### Front view

Rotisserie with roof (optional)  
and base on casters (optional)

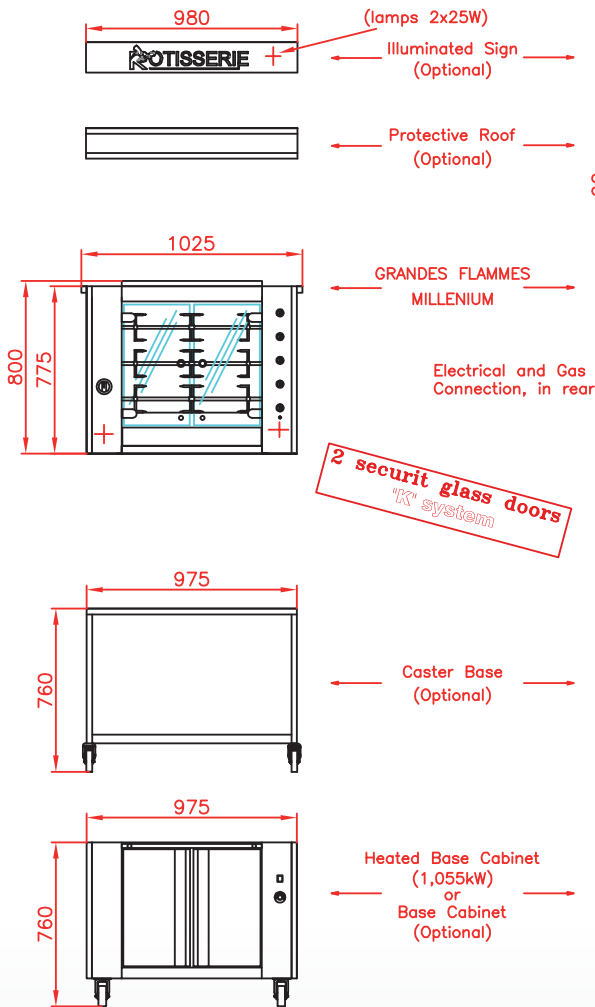

### Side view

Rotisserie with roof (optional)  
and base on casters (optional)

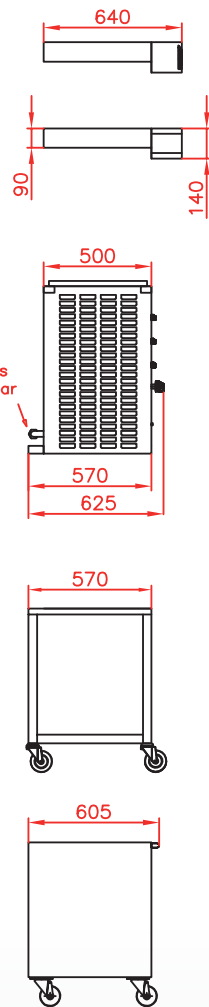

### Top view

Rotisserie with roof (optional)  
and base on casters (optional)

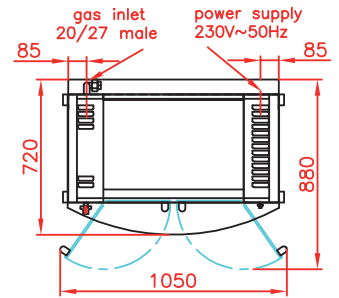

975.2MSG

Stainless steel with black enamel and chrome



Revised :  
December 2017

## SPECIFICATIONS

Capacity	6/9 poultries
Gas power	10 kW
Power supply	208-230V-50Hz/60Hz
Electrical power	0.34 kW
Weight and size (HxDxW)	120 kg ; 1625 x 720 x 1025 mm
Shipping weight and size	181 kg ; 1760 x 760 x 1070 mm
Guarantee	1 year parts



DISTRIBUTOR / AGENT

Rotisol S.A.S.

Zone industrielle La Trentaine, Avenue Gustave Eiffel  
77507 Chelles cedex - FRANCE

[s.bennell@rotisol.com](mailto:s.bennell@rotisol.com) - Tel : +33 1 64 21 80 00

[www.rotisol.com](http://www.rotisol.com)